

FEATURES

- SPL at any point in 3D space in near and far field
- Sound Power, Sensitivity, Directivity Index
- Polar Plot, Directivity Balloon, Contour Plot
- Automatic measurement of multiple transducers
- Superposition of multiple sound sources
- Simulation of beam steering and crossover settings

APPLICATIONS

- Line Arrays
- Sound bars
- Beam steering
- Crossover design

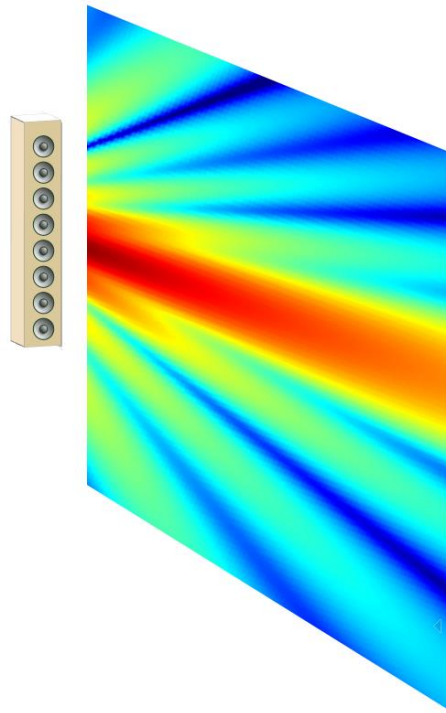

DESCRIPTION

Using traditional far field measurement techniques, determining directivity of large speaker array implicates a lot of difficulties for the data acquisition. Far field conditions cannot be reached because of the limited size of the most anechoic rooms and the very directional radiation pattern requires a time consuming measurement with high angular resolution ($<2^\circ$).

The holographic measurement method of the Near Field Scanner can cope with these particularities, but the complex sound field (especially near field effects) requires a high number of expansion terms and a lot of measurement points. Decomposing the speaker into the individual transducers by measuring with a multiplexer, the sound field of each source becomes relatively simple. Thus, the device can be described with a limited number of multipoles and a minimum number of measurement points.

In addition, the acquired source data includes diffraction effects of the loudspeaker cabinet and is an ideal base for further simulation e.g. beam steering.

CONTENT

- 1 Overview 3
- 2 Requirements 5
- 3 Performing a measurement 6
- 4 Data Processing 10
- 5 References 12
- 6 Trouble Shooting 12

1 Overview

1.1 Principle

The measurement is based on an elementary characteristic of sound waves, superposition. That means the complex sound pressure field of two individual sources (p_1 and p_2) can be summed to a resultant sound pressure field p_{total} .

$$p_{total} = p_1 + p_2$$

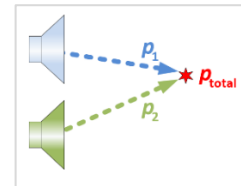

This application note shows how sound wave superposition can be combined with a holographic measurement system (NFS) to determine more accurate, versatile and comprehensive measurement data of large audio devices (e.g. Line Arrays, sound bars, etc.)

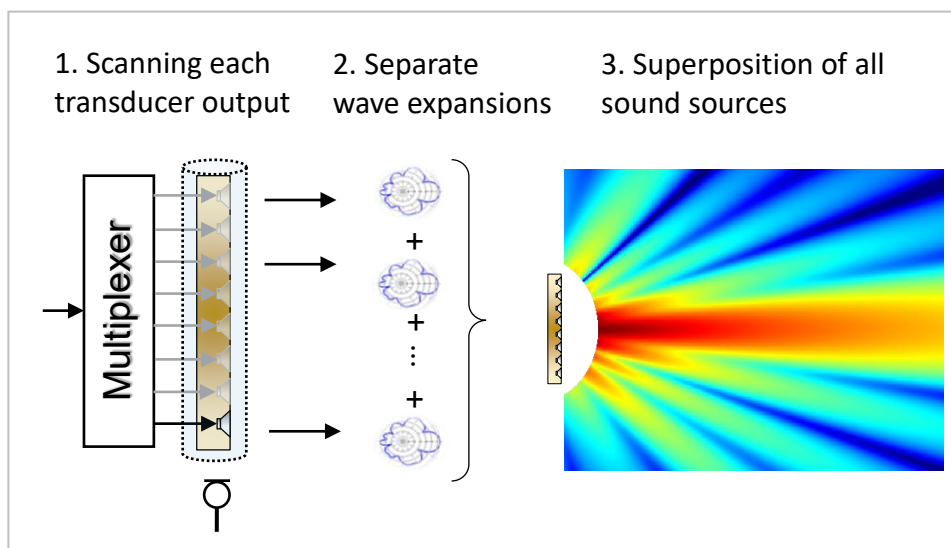

Step 1: Automatic measurement

At first a near field scan is performed. Using a multiplexer, each transducer is measured separately in only 1 scan. During the measurement the device under test is not moved to avoid positioning mismatches and determining accurate phase data for each transducer.

Step 2: Holographic Field Identification of each source

After the measurement, the sound field of each transducer is identified by the spherical wave expansion. Because of the separate measurements, the individual sources are relatively simple and the sound field can be modelled with a relative low number of expansion terms, saving measurement points and time.

Step 3: Superposition of sound sources

In the last processing step, the individual sources are superimposed in the visualization software to extrapolate the entire sound pressure output at any position in 3D space. In addition, adding a time delay or complex filter to each sound source the beam steering can be directly simulated based on the measured source data.

1.2 Measurement Results

Sound Pressure Level

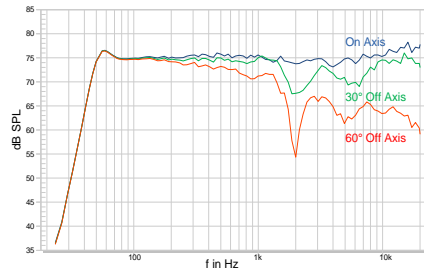

Sound Pressure Level over frequency at any position in 3D space.

Sound Power

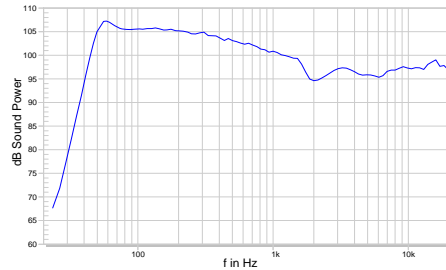

Total radiated Sound Power of the device under test.

Sound power characterizes the integrated sound pressure level over all radiation angles.

Directivity Index

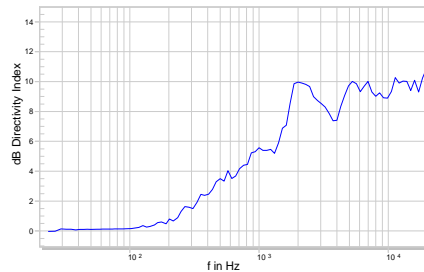

The Directivity Index summarizes the relation between the sound pressure levels of all radiation angles compared to the On-Axis sound pressure level.

An omnidirectional source has a directivity index of 0.

Sensitivity

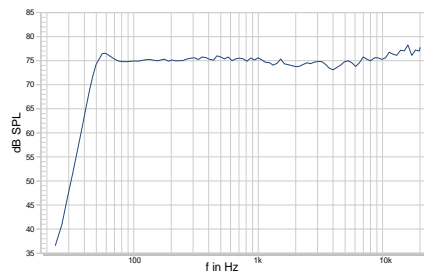

On-Axis sound pressure level referenced to 1m distance and 1W electrical input power (2.83V for 8Ω)

Contour Plot

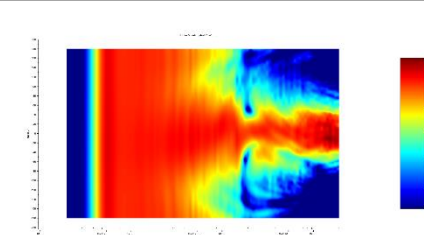

The contour plot visualizes the radiation behavior over frequency and the polar angle theta. The color scale indicates the Sound Pressure Level.

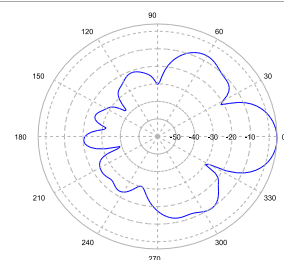

Polar Plot

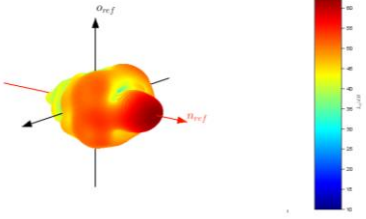

Polar plots visualize the radiation pattern over the polar angle theta for a specific frequency.

<p>Directivity Balloon</p>		<p>The balloon plot shows the radiation behaviour over phi and theta for a specific frequency.</p>
-----------------------------------	---	--

2 Requirements

<h3>2.1 Hardware</h3>			
<p>Near Field Scanner 3D</p>		<p>3D microphone positioning system comprising Hardware, Measurement Software and Visualization Software. [1]</p>	<p>C8</p>
<p>DA2 / KA3</p>		<p>Distortion Analyzer 2 or Klippel Analyzer 3 is the hardware platform for the measurement modules performing the signal generation, acquisition and digital signal processing in real time. [4]</p>	<p>H1</p>
<p>Multiplexer (Speakon or XLR)</p>		<p>8 channel multiplexing hardware that is directly controlled by the Klippel Software. [3]</p>	<p>A8</p>
<p>Microphone</p>		<p>Free field microphone with omnidirectional directivity characteristic over the desired measurement bandwidth.</p>	<p>A4</p>
<p>Amplifier (optional)</p>		<p>Amplifier with a flat frequency response over the desired measurement bandwidth</p>	
<h3>2.2 Software</h3>			
<p>Near Field Scanner System (C8)</p>	<p>Basic NFS package includes the measurement control, the basic post processing for anechoic measurements and the standard far field visualizations. [1]</p>		
<p>NFS Multi Source Superposition</p>	<p>Add-On module of the NFS Visualization Software that superimposes the sound field of multiple sound sources. [1]</p>		
<p>Klippel Robotics</p>	<p>The Robotics Software manages the data acquisition. That means it moves the NFS Hardware, switches the multiplexers and performs the measurements.</p>		
<p>NFS Direct Sound Separation</p>	<p>Required for non-anechoic measurement. Add-On module to perform the measurement in a non-anechoic environment. The field separation module separates room reflection from the direct sound of the DUT. [1]</p>		

3 Performing a measurement

3.1 Introduction

Targets

The example measurement of a two way loudspeaker system gives an overview of the measurement and analysis process of a NFS measurement with multiplexers.

The following questions will be discussed:

- How to setup a measurement using the multiplexer control of the measurement software?
- What are the particularities in the holographic processing (Field Identification)?
- What are the possibilities in the visualization?

 Please also see the *NFS Software Manual* for further information

Device under test

In the following example, a vented two way loudspeaker system is measured to show the basic workflow.

There is no limitation for the number of transducers. That means also sound bars or line arrays with much more transducers can be measured similar.



3.2 Start Klippel Robotics and create a new measurement

1) Start Klippel Robotics:



Open Robotics Software and click: **“New Measurement”**

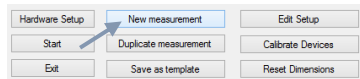

2) Select Template:

Choose “KITemplate_NFS.kdbx”.

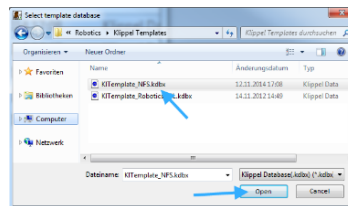

3) Select Results Path:

Select a folder and a name for the measurement database.

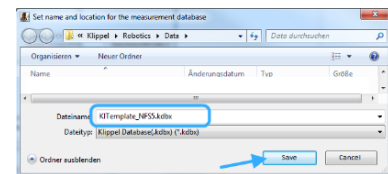

3.3 Hardware Setup

1) Open Hardware Setup:

Click: **“Hardware Setup”** to open the hardware dialog window.

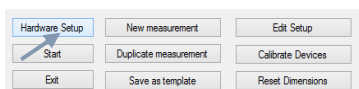

 In case of problem during the hardware setup, please see [Trouble Shooting](#)

2) Initialize Axes:

Click the **“Init”**-Button of each axis.

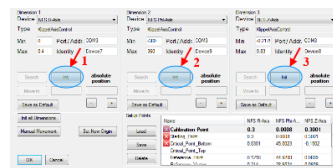

Please consider the correct order:
 1st: R-Axis (Dimension 1)
 2nd: Phi-Axis (Dimension 2)
 3rd: Z-Axis (Dimension 3)

3) Activate Remote Control:

Click **“Manual Movement”** to activate the Remote Control

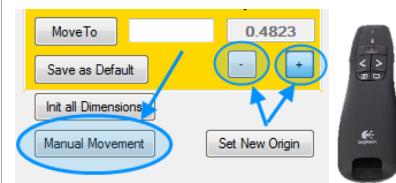

Now you can move the axes with the remote control or the - / + buttons, which is needed for the next steps.

4) Calibrate Microphone Position:

Clicking **“Set New Origin”** will open a calibration dialog



The microphone must be calibrated either at **“Origin”** (required for 1st calibration) or at **“Calibration Point”**.

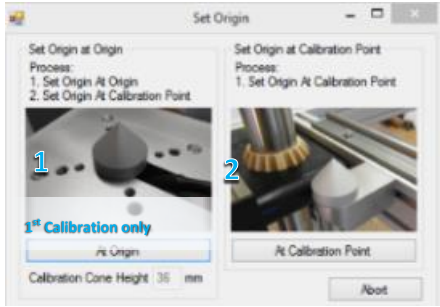

1) Origin (1st Calibration)

Put the cone to the Origin (center of plate)

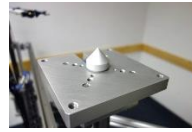

Drive the microphone to the tip of the cone (use remote)

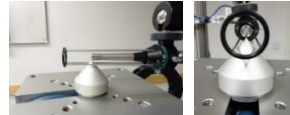

Confirm the position by clicking: **“At Origin”**

2) Calibration Point

Put the cone to the Calibration point.



Drive the microphone to the tip of the cone (use remote)



Confirm the position by clicking: **“At Calibration point”**



Drive the microphone close to the tip of the cone, but **do not hit the calibration cone.**

5) Configure Setup Points:

Put the loudspeaker on the Near Field Scanner and confirm all required setup points. Do the following procedure:

- 1) Drive microphone to the point
- 2) Select the Point in the List
- 3) Press **“Save”**

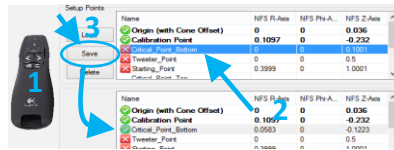

Save the position of the other transducers.

- 4) Scroll down the Setup Points List to see the point called **“MUXTweeterPoint2”**

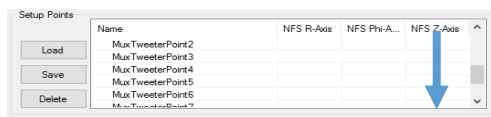

- 5) Drive the microphone in front of the woofer and save position.

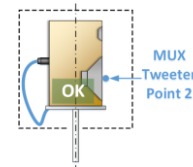

⚠ Avoid collision: Make sure that all obstacles are inside the surface.

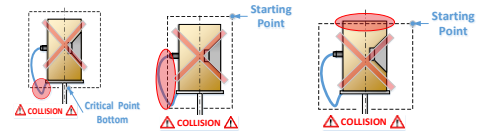

The following points have to be defined:

Critical Point Bottom

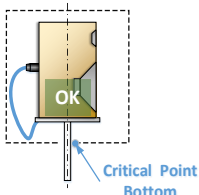

⚠ It must be below the platform and the tube and other obstacles must be inside the critical radius

Tweeter Point

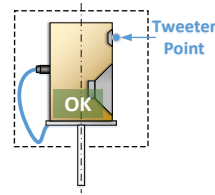

⚠ Set it approximately 5mm in front of the tweeter.

Starting Point

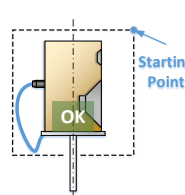

⚠ It must be above the upper edge and all obstacles must be inside the radius

3.4 Save Hardware Settings and Open Measurement Database

1) Confirm Hardware Settings:

Click **“OK”** to confirm your Settings

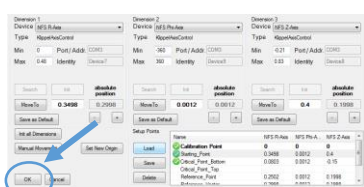

2) Open Database:

Click **“Edit Setup”** to open the database.

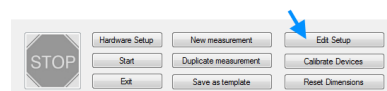

3) Select Setup Object:

Select the Object **“Setup”**. This Object consist of 3 Operation for the measurement configuration

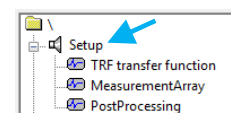

3.5 Measurement operation – TRF transfer function

1) Connect Hardware

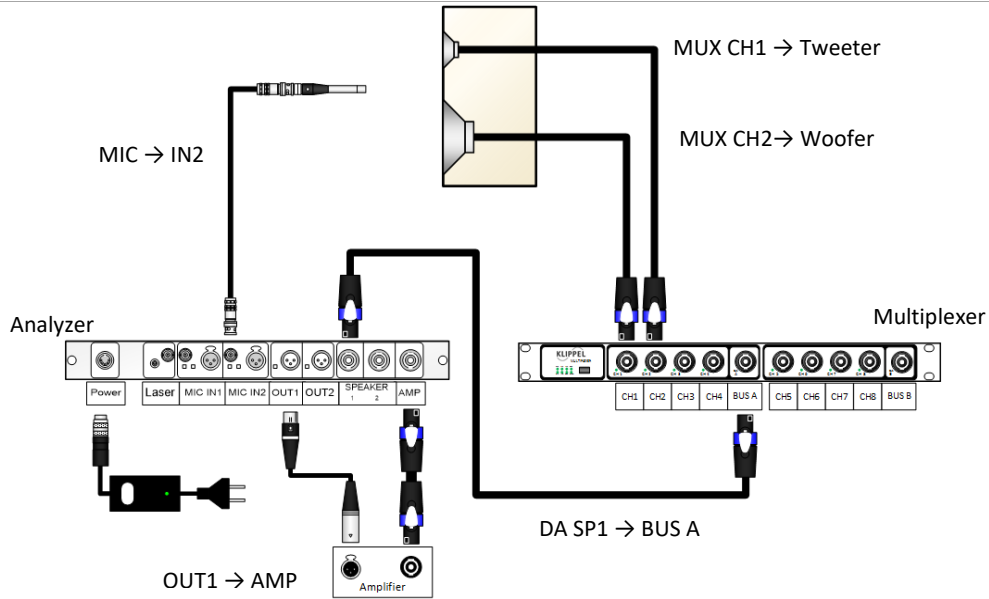

2) Select operation

Select the operation:
 "TRF transfer function"

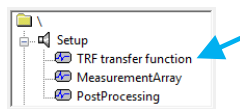

3) Property Page

Open "Property Page" to configure the measurement operation.



4) Configure Stimulus

Select the "Stimulus" tab and define:

- "Speaker 1 (via OUT1)"

Configure Parameters:

- Frequency Range (f_{min} , f_{max})
- Frequency Resolution
- Input Voltage

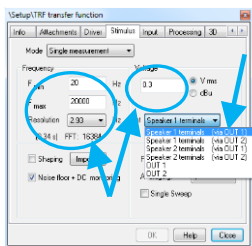

5) Define Channels and H(f)

1) Select the "Input" tab and define:

- Channel 1 – (Voltage Speaker 1) Us
- Channel 2 - IN 2 (Mic)

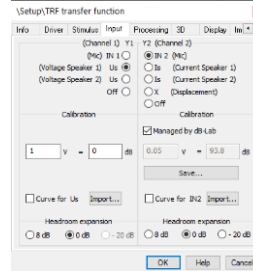

2) Select the "Processing" Tab and define: $H(f) = IN2 / Us$

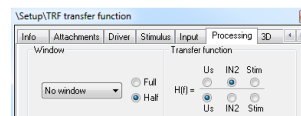

6) Switch Multiplexer and Run Operation

- 1) Click the manual switch button of the MUX.
- 2) And route "BUS A" to "CH 1" to connect the Tweeter.

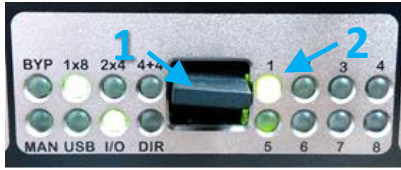

! If the routing with the manual switch is not possible please see the multiplexer manual [7]

Run the TRF operation by clicking on the green arrow.



! The measurement should be performed in front of the loud-speaker. Move the microphone to the On-Axis position.

7) Check SNR

Open the Result Windows "Y1(f) Spectrum" and "Y2(f) Spectrum". Check if the microphone signal has a Signal to Noise Ratio (SNR) of at least 40dB in the passband.

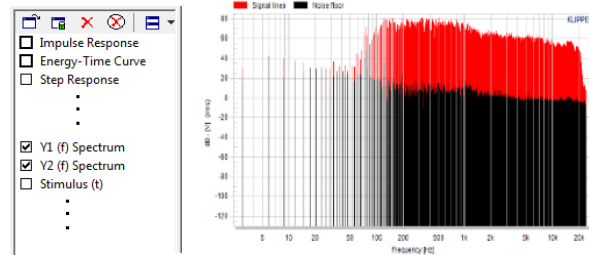

If the SNR is less increase the voltage of the Stimulus or apply averaging.

Repeat the same check for the Woofer. ("BUS A" to "CH2")

3.6 Measurement Array

1) Select Operation

Select the operation: "MeasurementArray"

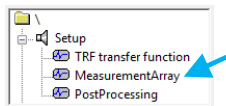

and open the Property Page.



2) Grid Configuration

Open the "Input" tab to configure the Parameter, listed under "Grid Configuration". Please define:

- Number of Points
- Use Direct Sound Separation
- Reflection Free Distance
- Frequency Resolution

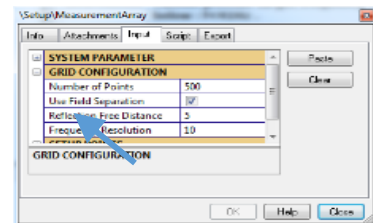

! See the "Documentation" window, for information about the parameters.

3) Measurement Operation and Multiplexer settings

Step 1: Reset Configuration

- 1) Open the Category **Measurement Setup**
- 2) Click **Delete all Operations** to reset the Operation List

Measurement Setup	
Operation List	New Operation
Measurement Module	TRF transfer function
Use Multiplexer	<input type="checkbox"/>
Save Operation in List	
Delete Operation	
Delete All Operations	

Step 2: Select Measurement Module

- 1) Select "New Operation" in the Operation List
- 2) Select the Module for the measurement e.g. "TRF transfer function"

Measurement Setup	
Operation List	New Operation ← 1)
Measurement Module	TRF transfer function ← 2)
Use Multiplexer	<input type="checkbox"/>
Save Operation in List	
Delete Operation	
Delete All Operations	

Step 3: Configure Multiplexer Settings

- 1) To add a switching configuration of a MUX click **Use Multiplexer**
- 2) Select in the list the MUX that should be switched or **Update List** to see all MUXes

Measurement Setup	
Operation List	New Operation
Measurement Module	TRF transfer function
Use Multiplexer	<input checked="" type="checkbox"/> ← 1)
Select Multiplexer	- ← 2)
MUX - Activate	Update List
<input type="checkbox"/> Transducer Position/...	-

- 3) Click **MUX-Activate** to activate the multiplexer.
- 4) Adjust the switching configuration. For the Tweeter set: Mode: **1x8**, Ch.: **1 to A/B**
- 5) Click **Switch Configuration** to switch the MUX and check your configuration

Measurement Setup	
Operation List	New Operation
Measurement Module	TRF transfer function
Use Multiplexer	<input checked="" type="checkbox"/>
Select Multiplexer	MUX 0021 ← 3)
MUX - Activate	<input checked="" type="checkbox"/>
MUX - Mode	1x8 ← 4)
MUX - Channel1	1 > A/B ← 4)
MUX - IEPE Supply Ch1-4	<input type="checkbox"/>
MUX - Switch Configuration ← 5)	

Step 4: Transducer Name + Save Configuration

- 1) To save the results in a separate data container, set the parameter **Transducer Position/Name:** E.g. "Tweeter"
- 2) Click **Save in Operation List** to store the current Setup

Select Multiplexer	MUX 0021
MUX - Activate	<input checked="" type="checkbox"/>
MUX - Mode	1x8
MUX - Channel1	1 > A/B
MUX - IEPE Supply Ch1-4	<input type="checkbox"/>
MUX - Switch Configuration	
<input checked="" type="checkbox"/> Transducer Position/...	Tweeter
Save Operation in List	

Setup for Woofer

Repeat step 2-4 for the Woofer

Use the following Settings:

- MUX – Mode: **1x8**
- MUX – Channel: **2 > A/B**
- Transducer Position/Name: **Woofer**

MUX - Mode	1x8
MUX - Channel1	1 > A/B
MUX - IEPE Supply Ch1-4	<input type="checkbox"/>
MUX - Switch Configuration	
<input checked="" type="checkbox"/> Transducer Position/...	Woofer
Save Operation in List	

4) Run Operation

Run the Measurement Array operation by clicking on the green arrow.



After running the Script the measurement points and the multiplexer settings are shown in a table in the Result window **Table Measurement Points.**

NUMBER OF POINTS: 1038							
n	r in m	phi in degrees	z in m	Operation	Speaker	Mux Commands	
1	.3185924	-172.87957	.5004	TRF transfer function	Woofer	MUX 0109, set1x8 1 MUX 0109, set1cp 1 off	
2	.3185924	-172.87957	.5004	TRF transfer function	Tweeter	MUX 0109, set1x8 2 MUX 0109, set1cp 1 off	
3	.3358273	-164.37106	.4504	TRF transfer function	Woofer	MUX 0109, set1x8 1 MUX 0109, set1cp 1 off	
4	.3358273	-164.37106	.4504	TRF transfer function	Tweeter	MUX 0109, set1x8 2 MUX 0109, set1cp 1 off	
5	.1210646	-156.76575	.4504	TRF transfer function	Woofer	MUX 0109, set1x8 1 MUX 0109, set1cp 1 off	

3.7 Start Measurement

Close database to get back to the Robotics and Press **"Start"**

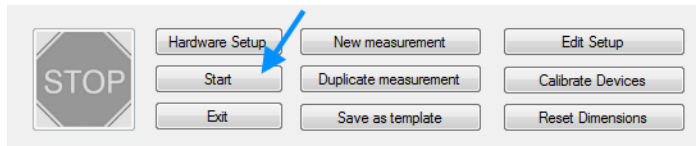

Press **"Continue"** to Start the measurement. In the following, the Robotics Software will control the automatic measurement.



4 Data Processing

4.1 Result Database

1) Open Database

After the measurement has finished, click **Show Result dB** to open the Database

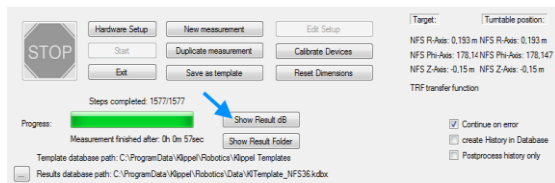

2) Database Structure

Open the Object **Processing**

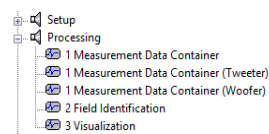

After the measurement this Object should contain 2 Data Containers with names of the defined Transducer names. (e.g. "Tweeter" and "Woofer")

4.2 Measurement Data Containers



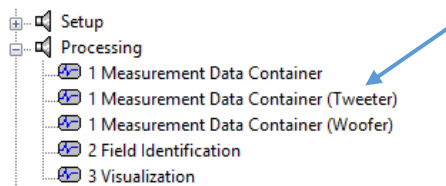

1) Select Data Container (Tweeter)

Select Operation:

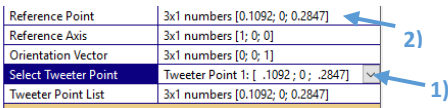

1 Measurement Data Container (Tweeter)

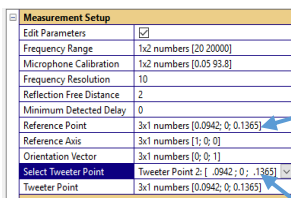

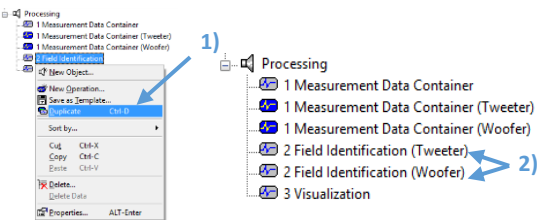
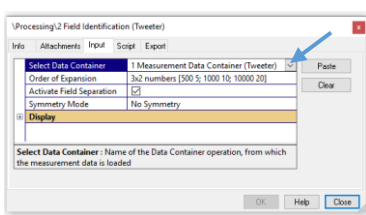

Open the **Property Page**

<p>2) Set Tweeter Point and Reference Point</p>	<p>3) Configure Data Container (Woofer)</p>
<p>1) Select from the List of saved Tweeter Points the position that is in front of the tweeter. (e.g. Tweeter Point 1)</p> <p>2) Set the Reference Point to same position, by copying the coordinates.</p>	<p>Repeat 1) and 2) for the Measurement Data Container of the Woofer</p>
	<p>1) Select Tweeter Point</p> <p>2) Set Reference Point</p> <p>3) Run Operation </p> 
<p>3) Run the operation </p>	

4.3 Field Identification

<p>1) Duplicate and rename Field Identification</p>	<p>2) Select Data Containers and Run Operations</p>
<p>1) Right click the Operation "2 Field Identification" and select Duplicate</p> <p>2) Give both Field Identifications a clear name e.g. use the transducer names "Tweeter" and "Woofer"</p>	<p>Open Property Page of the Field Identification module and make sure the correct Data Container is selected (e.g. Tweeter)</p>
	 <p>When the configuration is fine, Run  module</p>

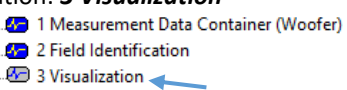
4.4 Visualization

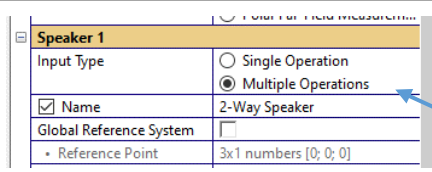
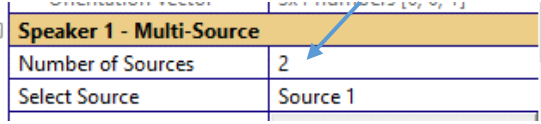
<p>1) Select Visualization</p>	<p>Open the Property Page</p>
<p>Select Operation: 3 Visualization</p> 	
<p>2) Activate Multiple Source Mode</p>	<p>3) Configure Number of Source</p>
 <p>Add-On Module required: NFS Multi Source Superposition</p>	<p>Open the Category "Speaker 1 - Multi-Source" and define the number of sources. For this example 2</p> 

4) Configure Multi Source - Source Settings

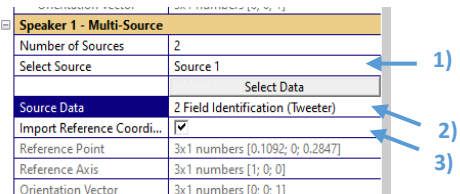
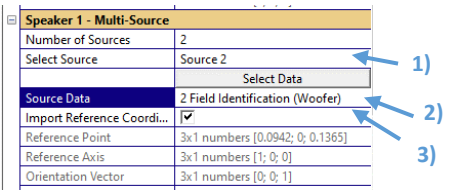





<p>Configuration of Tweeter:</p>	<p>Configuration of Woofer:</p>
<p>1) Select Source 1</p> <p>2) Choose source data: 2 Field Identification (Tweeter)</p>	<p>1) Select Source 2</p> <p>2) Choose source data: 2 Field Identification (Woofer)</p>
<p>3) Check Import Parameter to load Reference Point</p>	<p>3) Check Import Parameter to load Reference Point</p>
	



<p>5) Global Reference Point</p> <p>Define a Global Reference Point. E.g. Set to the Position of the Woofer</p> <table border="1"> <tr> <th colspan="2">Multi Source - Global Settings</th> </tr> <tr> <td>Select Speaker</td> <td>Speaker 1 - 2 Way System</td> </tr> <tr> <td>Number of Multi Sources</td> <td>2</td> </tr> <tr> <td>Global Reference Point</td> <td>3x1 numbers [0.0942; 0; 0.1365] </td> </tr> <tr> <td>Global Reference Axis</td> <td>3x1 numbers [1; 0; 0]</td> </tr> <tr> <td>Global Orientation Vector</td> <td>3x1 numbers [0; 0; 1]</td> </tr> </table>	Multi Source - Global Settings		Select Speaker	Speaker 1 - 2 Way System	Number of Multi Sources	2	Global Reference Point	3x1 numbers [0.0942; 0; 0.1365]	Global Reference Axis	3x1 numbers [1; 0; 0]	Global Orientation Vector	3x1 numbers [0; 0; 1]	<p>6) Run Visualization</p> <p>Click the green arrow to run the operation. This will start the calculation. After data is calculated the sound field can be analyzed interactively.</p> <hr/> <p>For more information please see the NFS Tutorial Part 1</p>
Multi Source - Global Settings													
Select Speaker	Speaker 1 - 2 Way System												
Number of Multi Sources	2												
Global Reference Point	3x1 numbers [0.0942; 0; 0.1365]												
Global Reference Axis	3x1 numbers [1; 0; 0]												
Global Orientation Vector	3x1 numbers [0; 0; 1]												

5 References

<p>5.1 Related Modules</p>	<p>[1] <i>Near Field Scanner 3D (NFS)</i>, Specification C8, 2016 Klippel GmbH, www.klippel.de</p> <p>[2] <i>Transfer function (TRF)</i>, Specification S7, 2016 Klippel GmbH, www.klippel.de</p> <p>[3] <i>Multiplexer</i>, Specification A8, 2016 Klippel GmbH, www.klippel.de</p> <p>[4] <i>Distortion Analyzer 2</i>, Specification H1, 2016 Klippel GmbH, www.klippel.de</p>
<p>5.2 Manuals</p>	<p>[5] User Manual <i>Near Field Scanner 3D (NFS)</i>, included in NFS Software installation</p> <p>[6] User Manual TRF Transfer function, included in dB-Lab Software installation</p> <p>[7] User Manual MUX, included in dB-Lab Software installation</p>
<p>5.3 Publications</p>	<p>[8] W. Klippel, C. Bellmann: <i>Holographic Nearfield Measurement of Loudspeaker Directivity</i>, AES 2016 - 141th Convention, Audio Engineering Society</p> <p>[9] C. Bellmann, W. Klippel, D. Knobloch: <i>Holographic loudspeaker measurement based on near field scanning</i>, DAGA 2015 - 41th Convention, DEGA e.V.</p>
<p>5.4 Standards</p>	<p>[10] IEC (E) 60268-21: <i>Acoustical (Output based) Measurements</i>, 2015 International Electrotechnical Commission</p> <p>[11] IEC 62777 Ed.1: <i>Quality Evaluation Method for the Sound Field of Directional Loudspeaker Array System</i>, 2014 International Electrotechnical Commission</p> <p>[12] CEA-2034: <i>Standard Method of Measurement for In-Home Loudspeakers</i>, 2013 Consumer Electronics Association</p>

6 Trouble Shooting

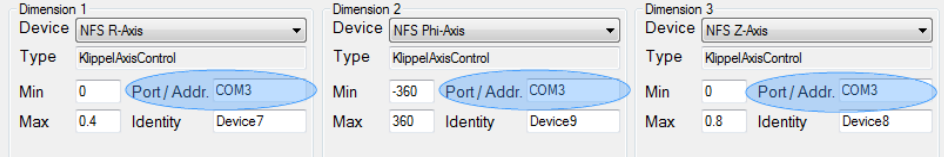
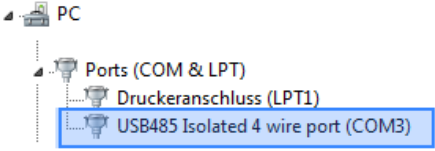
<p>6.1 Error: Nanotec Device not connected</p>	
<p>1) Check Power Supply</p>	<p>1) Check the 5V and 24V LEDs at the motor boxes.</p> <p>If they are on, everything is OK with the power supply.</p> 
	<p>2) Check Emergency Stop</p> <div style="display: flex; justify-content: space-around;"> <div style="text-align: center;">  <p>Emergency Stop pressed: Power is OFF</p> </div> <div style="text-align: center;">  <p>Emergency Stop lifted: Power is ON</p> </div> </div>
	<p>3) Check Power Switch</p> <div style="display: flex; justify-content: space-around;"> <div style="text-align: center;">  <p>Power is OFF</p> </div> <div style="text-align: center;">  <p>Power is ON</p> </div> </div>
	<p>4) Check all power connections</p> 

<p>2) Check COM-Port</p>	<p>Check if the devices are assigned correctly.</p> <p>Dimension 1: NFS R-Axis Port/Addr.: COM<Portnumber></p> <p>Dimension 2: NFS Phi-Axis Port/Addr.: COM<Portnumber></p> <p>Dimension 3: NFS Z-Axis Port/Addr.: COM<Portnumber></p>  <p>Please check the Windows device manager, which COM-Port has been assigned to the USB-RS485 converter. (How to open device manager?)</p>  <p>Use this port number and enter it in the Port/Addr field. (e.g. for COM port 3 enter "COM3" into the Port/Addr field)</p>	
<p>3) Check RS485 Bus</p>	<p>Reconnect RS485-USB adapter to PC</p> 	<p>Check BUS connection at the motor boxes</p> 

6.2 How does the Remote Control work?



Movement Modes:

Continuous Movement - Rough Positioning

Dragging a movement **Button**, the Axis accelerate at first and continue with a **uniform speed**. Lifting the button stops the motion.

Single Step Mode – Precise Positioning

Pressing shortly a movement **Button**, the Axis will move a **single step**.

6.3 Microphone cannot reach “Origin”/ “Calibration Point”

1) Check Position of End switches

Check if the minimum Endswitch of R-Axis is placed correctly

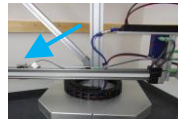

It is supposed to be above the edge of the table, so the motor does not hit the foot structure.

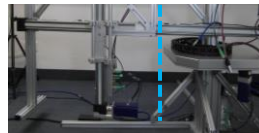

Drive the microphone into the minimum end switch of the Z-axis and check microphone position. It should be about 1cm above the frame structure.

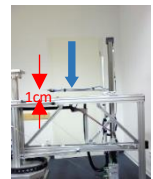

Caution: Take care, that the microphone pole will not hit the structure.

Check the position of the Z-Axis End switches, as well.



2) Adjust Microphone arm by hand

For the rough positioning, loose the screw at the connector and shift the microphone pole.



Adjust the microphone position precisely using the ball-joint microphone adapter.

- 1) Loose the screw of the connector.
- 2) Shift the microphone by hand to correct position.
- 3) Tight the connector screw.

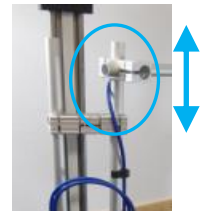

After finishing the mechanical adjustment. The calibration must be repeated at the Origin.



Find explanations for symbols at:

<http://www.klippel.de/know-how/literature.html>

Last updated: June 18, 2021

